

**Ersatzteilkatalog
Spare Parts Catalogue
Catalogue de Pièces de Rechange
Catálogo de Piezas de Repuesto
Yedek Parça katalođu**

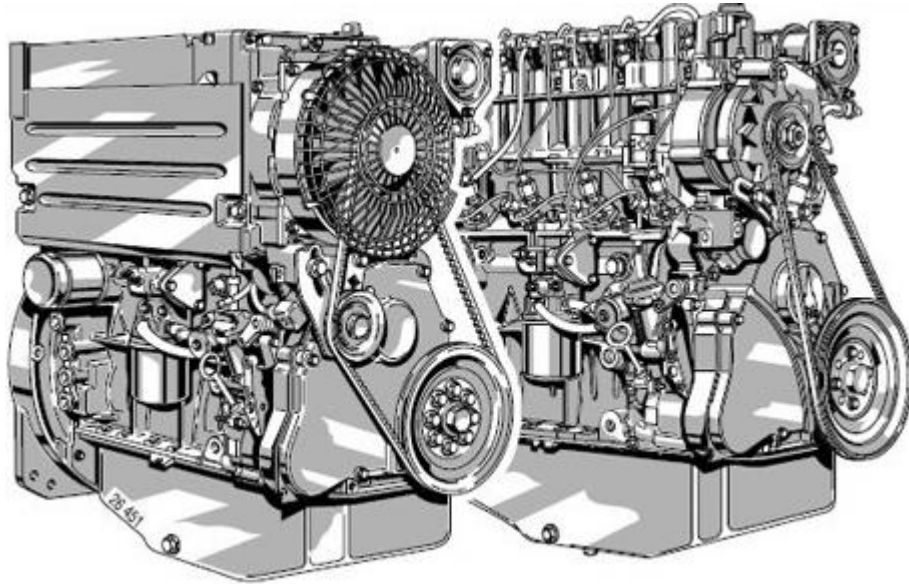

**REPLACEMENT PARTS
FOR
DEUTZ ENGINES**

**F 2L1011 - F 3L1011 - F 4L1011
BF 3L1011F - BF 3M1011F
BF 4L1011F - BF 4M1011F**

January - 2016



**Emre Otomotiv Motorlu Araçlar Yedek Parça San. Ve Tic. Ltd. Şti.
The Engine Spare Parts Company**

www.emreparts.com & www.burkertparts.com

- **EMRE OTOMOTIV** vehicle parts are not offered as original spare parts but they are our own products. We guarantee highest quality and full interchangeability.
- Alterations will be given by issuing a new catalogue. When changing please observe the date of issue. The invalid catalogue is to be thrown away immediately.
- In case only the original number of the vehicle manufacturer is known the parts can be determined by means of the list showing the original numbers in comparison with the **EMRE OTOMOTIV** nos.
- The information contained in this catalogue has been compiled carefully by means of documentations and information available. However, we do not accept any responsibility in case of errors or omissions. We reserve all rights to make technical changes.
- The original number of the vehicle manufacturer may be used for comparison only, and must not be mentioned on invoices to vehicle owners.
- A reproduction –also in extracts- is only permitted with the written approval of **EMRE OTOMOTIV**.



**EMRE OTOMOTIV MOTORLU ARAÇLAR
YEDEK PARÇA SAN. VE TİC. LTD. ŞTİ
2016**

PHOTOS	DESCRIPTIONS	PARTS NUMBER	ENGINE TYPE
	CRANKSHAFT Krank Mili	B – 292 8288 0292 8288 0427 0231 0428 7292	DEUTZ F 2L1011 / F 2L1011F F 2M1011
	CRANKSHAFT Krank Mili	B – 213 6928 0415 2646 0427 0229 0292 8289 0428 7293 0292 9796 0429 8719	DEUTZ F3L 1011 / F3L 1011F
	CRANKSHAFT Krank Mili	B – 292 8290 0292 8290 0292 8166 0427 0233 0428 7294	DEUTZ F4L 1011 / F4L 1011F
	CONNECTING ROD Piston Kolu <i>Pin Ø30,00 mm</i>	B – 417 8999 0417 8999 0417 4410	DEUTZ BF/L 1011F Turbo BF/M 1011F BF/M 1011FT
	CONNECTING ROD Piston Kolu <i>Pin Ø26,00 mm</i>	B – 417 8994 0417 8994 0210 9018 0428 6649	DEUTZ F/L 1011 F/M 1011
	BIG END BEARING – STD – Kol Yatak	B – 427 0255.STD 0292 8967 0427 0255 0292 7195	DEUTZ FL 1011 / FL 1011F
	BIG END BEARING – 0,25 – Kol Yatak	B – 427 0255.025 0292 8968 0427 0259	DEUTZ FL 1011 / FL 1011F

PHOTOS	DESCRIPTIONS	PARTS NUMBER	ENGINE TYPE
	BIG END BEARING – 0,50 – Kol Yatak	B – 427 0255.050 0292 8969 0427 0263	DEUTZ FL 1011 / FL 1011F
	BIG END BEARING – 0,75 – Kol Yatak	B – 427 0255.075	DEUTZ FL 1011 / FL 1011F
	MAIN BEARING – STD – Ana Yatak	B – 427 0238.STD 0427 0238 0417 8552 0292 8957	DEUTZ FL 1011 / FL 1011F
	MAIN BEARING – 0,25 – Ana Yatak	B – 427 238.025 0427 0242 0292 8958	DEUTZ FL 1011 / FL 1011F
	MAIN BEARING – 0,50 – Ana Yatak	B – 427 0238.50 0427 0247 0292 8959	DEUTZ FL 1011 / FL 1011F
	MAIN BEARING – 0,75 – Ana Yatak	B – 427 0238.75	DEUTZ FL 1011 / FL 1011F
	THRUST WASHER – STD – Kenar (Ay) Yatak	B – 292 8961.STD 0292 8961	DEUTZ FL 1011 / FL 1011F

PHOTOS	DESCRIPTIONS	PARTS NUMBER	ENGINE TYPE
	THRUST WASHER – 0,25 – Kenar (Ay) Yatak	B - 292 8961.025 0292 8962	DEUTZ FL 1011 / FL 1011F
	THRUST WASHER – 0,50 – Kenar (Ay) Yatak	B – 292 8961.050	DEUTZ FL 1011 / FL 1011F
	BIG END BUSH Kol Burcu <i>Pin Ø30,00 MM</i>	B – 417 0393 0417 0393	DEUTZ BF/L 1011F Turbo
	BIG END BUSH Kol Burcu <i>Pin Ø26,00 MM</i>	B – 210 8088 0210 8088	DEUTZ F/L 1011
	BEARING (CAMSHAFT) BUSH Eksantrik Mil Burcu <i>Narrow Type / Dar Tip</i> <i>Ø51,10*55,00*17,00 mm</i>	B – 417 0110 0417 0110	DEUTZ FL 1011
	BEARING (CAMSHAFT) BUSH Eksantrik Mil Burcu <i>Wide Type / Geniş Tip</i> <i>Ø51,00*55,00*23,10 mm</i>	B – 417 0107 0417 0107	DEUTZ FL 1011
	BEARING (CAMSHAFT) BUSH <i>Narrow Type / Dar Tip</i>	B – 417 8154 0417 8154	DEUTZ BF/L1011F Turbo BF/M1011F Turbo





PHOTOS	DESCRIPTIONS	PARTS NUMBER	ENGINE TYPE
	BEARING (CAMSHAFT) BUSH Eksantrik Mil Burcu <i>Wide Type / Geniş Tip</i>	B – 417 8155 0417 8155	DEUTZ BF/L1011F Turbo BF/M1011F Turbo
	BIG END BOLT Piston Kol Cıvatası M10x1x74 mm	B – 417 8991 0417 8991 2904106	DEUTZ FL 1011 / FL 1011F
	CYLINDER HEAD BOLT Silindir Kapak Saplaması M14x2x185 mm	B – 210 9444 0210 9444	DEUTZ BFL/M 1011 / F Turbo
	CYLINDER HEAD BOLT Silindir Kapak Saplaması M14x2x151 mm	B – 417 8044 0417 8044 0427 0815	DEUTZ FL 1011
	FLYWHEEL RING GEAR Volan Dişlisi <i>Thin Type / İnce Tip</i>	B – 417 6379 0417 6379 0417 1009 0417 6379 0417 1081	DEUTZ FL 1011 / FL 1011F
	FLYWHEEL RING GEAR Volan Dişlisi <i>Thick Type / Kalın Tip</i>	B– 417 1009 0417 1009	DEUTZ FL 1011 / FL 1011F
	CYLINDER LINER Gömlek Inner Ø [mm]:91.00 Outer Ø [mm]:94.015	B – 417 9444 0417 9444 0417 0347	DEUTZ FL 1011 / FL 1011F

PHOTOS	DESCRIPTIONS	PARTS NUMBER	ENGINE TYPE
	<p>PISTON</p> <p>Ø91,00 MM Pim Ø26,00*65,00 mm</p>	<p>B – 13.03043.00 0427 1031</p>	<p>DEUTZ FL 1011</p>
	<p>PISTON (Short Type / Kısa Tip)</p> <p>Ø91,00 MM Pin Ø26,00*65,00 mm</p>	<p>B – 13.03044.00 0427 1217</p>	<p>DEUTZ FL 1011</p>
	<p>PISTON</p> <p>Ø91,00 MM Pin Ø30,00*68,00 mm</p>	<p>B – 13.03049.00 87-71310-STDB</p>	<p>DEUTZ FL 1011F Turbo</p>
	<p>PISTON RING SET Segman</p> <p>Ø91,00 MM (2,00*2,00*3,00)</p>	<p>B – 06.862800-20 0417 8311</p>	<p>DEUTZ FL 1011 / FL 1011F</p>
	<p>PISTON RING SET Segman</p> <p>Ø91,50 MM (2,00*2,00*3,00)</p>	<p>B – 06.862807-20</p>	<p>DEUTZ FL 1011 / FL 1011F</p>
	<p>PISTON RING SET Segman</p> <p>Ø92,00 MM (2,00*2,00*3,00)</p>	<p>B – 06.252511-00</p>	<p>DEUTZ FL 1011 / FL 1011F</p>
	<p>PISTON RING SET Segman</p> <p>Ø91,00 MM (3,00*2,00*3,00)</p>	<p>B – 06.862100-80 0417 3461</p>	<p>DEUTZ FL 1011F / Turbo</p>

PHOTOS	DESCRIPTIONS	PARTS NUMBER	ENGINE TYPE
	PISTON RING SET Segman Ø91,50 MM (3,00*2,00*3,00)	B – 06.862107-80	DEUTZ FL 1011F / Turbo
	ROCKER ARM BRACKET KIT Komple Piyano Kütüğü	B – 417 4058 0417 4058	DEUTZ FL 1011 / FL 1011F
	ROCKER ARM Piyano Horozu	B – 210 9428 0210 9428	DEUTZ FL 1011 / FL 1011F
	ROCKER ARM BRACKET Piyano Kütüğü	B – 417 4058 0417 4058	DEUTZ FL 1011 / FL 1011F
	ADJUSTING SCREW Piyano Civatası	B – 210 9636 0210 9636	DEUTZ FL 1011 / FL 1011F
	PUSH ROD Supap İtecek Mili	B – 210 9085 0210 9085	DEUTZ FL 1011 / FL 1011F
	VALVE SPRING Supap Yayı	B – 417 9633 0417 9633	DEUTZ FL 1011 / FL 1011F





PHOTOS	DESCRIPTIONS	PARTS NUMBER	ENGINE TYPE
	VALVE SPRING Supap Yayı	B – 210 8074 0210 8074	DEUTZ FL 1011 / FL 1011F
	EXHAUST VALVE Supap Egzoz	B – 417 0899 0417 0899	DEUTZ FL 1011 / FL 1011F Turbo
	INTAKE VALVE Supap Emme	B – 427 2209	DEUTZ FL 1011
	INTAKE VALVE 30° Supap Emme 30°	B – 427 2394 0427 2394	DEUTZ FL 1011F Turbo
	VALVE SEAT – Ex. Supap Bakası Egzoz	B – 210 8633 0210 8633	DEUTZ FL 1011 / FL 1011F
	VALVE SEAT – In. I Supap Bakası Emme	B – 417 0178 0417 0178	DEUTZ FL 1011 / FL 1011F
	VALVE SEAT – In. 30° Supap Bakası Emme 30°	B – 417 0172 0417 0172	DEUTZ FL 1011 / FL 1011F

PHOTOS	DESCRIPTIONS	PARTS NUMBER	ENGINE TYPE
	VALVE GUIDE Supap Gaydı	B – 417 0164 0417 0164	DEUTZ FL 1011 / FL 1011F
	VALVE TAPPET Supap Fincanı	B – 417 8075 0417 8075	DEUTZ FL 1011 / FL 1011F
	ROLLER TAPPET Supap Tappet	B – 417 3297 0410 3297 0428 6744 0428 6793 0428 6884 0428 7698 0430 0260	DEUTZ FL 1011 / FL 1011F
	OIL RADIATOR PIPE (Long Type) Yağ Radyatör Borusu (Uzun Tip)	B – 417 9404 0417 9404	DEUTZ FL 1011 / FL 1011F
	OIL RADIATOR PIPE (Short Type) Yağ Radyatör Borusu (Kısa Tip)	B – 415 4841 0415 4841	DEUTZ FL 1011 / FL 1011F
	INJECTOR PIPE SET Enjektör Boru Seti	B – 210 9774 0210 9774	DEUTZ FL 1011 / FL 1011F
	OIL PRESSURE SWITCH	B – 419 0850 0419 0850	DEUTZ FL 1011 / FL 1011F







PHOTOS	DESCRIPTIONS	PARTS NUMBER	ENGINE TYPE
	<p>OIL TEMPERATURE SENSOR</p>	<p>B – 117 9305 0117 9305</p>	<p>DEUTZ FL 1011 / FL 1011F</p>
	<p>OIL NOZZLE Engine Block</p>	<p>B – 417 8452 0417 8452</p>	<p>DEUTZ FL 1011 / FL 1011F</p>
	<p>STOP SOLENOID 24/V With Cable</p>	<p>B – 410 2390 0410 2390 0410 3812 0428 7116 0428 7583</p>	<p>DEUTZ FL 1011 / FL 1011F</p>
	<p>STOP SOLENOID 12/V With Cable</p>	<p>B – 428 7584 0428 7584</p>	<p>DEUTZ FL 1011 / FL 1011F</p>
	<p>STOP SOLENOID 12/V With Cable</p>	<p>B – 410 3812 0410 3812</p>	<p>DEUTZ FL 1011 / FL 1011F</p>
	<p>STOP SOLENOID 12/V Without Cable</p>	<p>B – 427 2733 0427 2733</p>	<p>DEUTZ FL 1011 / FL 1011F</p>
	<p>BELT TENSIONER</p>	<p>B – 417 5031 0417 5031 0417 5633 0417 5647</p>	<p>DEUTZ FL 1011 / FL 1011F</p>

PHOTOS	DESCRIPTIONS	PARTS NUMBER	ENGINE TYPE
	<p>TIMING BELT BEARING</p>	<p>B – GB3168</p>	<p>DEUTZ FL 1011 / FL 1011F</p>
	<p>TIMING BELT (091x254 H)</p>	<p>D – 094 525 091 RHDN 254HM 15 251083</p>	<p>DEUTZ FL 1011 / FL 1011F</p>
	<p>TIMING BELT REPAIR KIT (Belt with Bearing)</p>	<p>B – 292 9933 0292 9933 0293 7741</p>	<p>DEUTZ FL 1011 / FL 1011F</p>
	<p>STARTER ASSEMBLY 2.2KW 12V 11T CW</p>	<p>B – 118 0180 0118 0180</p>	<p>DEUTZ FL 1011 / FL 1011F</p>
	<p>FUEL TRANSFER PUMP</p>	<p>B – 417 5474 0417 5474</p>	<p>DEUTZ FL 1011</p>
	<p>FUEL TRANSFER PUMP</p>	<p>B – 417 9734 0417 9734</p>	<p>DEUTZ BF/L 1011F Turbo</p>
	<p>OIL PUMP</p>	<p>B – 0417 5573 0417 5573</p>	<p>DEUTZ FL 1011</p>

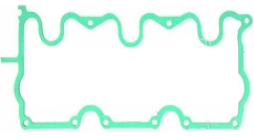





PHOTOS	DESCRIPTIONS	PARTS NUMBER	ENGINE TYPE
	OIL PUMP	B – 417 8968 0417 8968	DEUTZ FL 1011F Turbo
	TURBO HOSE	B – 427 1258 0427 1258	DEUTZ FL 1011F Turbo
	INJECTOR PUMP	B – 417 9429 0417 9429 0 414 287 014	DEUTZ FL 1011 / FL 1011F
	INJECTOR PUMP	B – 417 5175 0417 5175 0 414 287 004	DEUTZ FL 1011 / FL 1011F
	INJECTOR PUMP	B – 417 5848 0417 5848 0 414 287 007	DEUTZ FL 1011 / FL 1011F
	INJECTOR PUMP	B – 417 8024 0417 8024 0 432 191 627	DEUTZ FL 1011 / FL 1011F
	INJECTOR NOZZEL	B – 417 5187 0417 5187 DLLA149P11334	DEUTZ FL 1011 / FL 1011F

PHOTOS	DESCRIPTIONS	PARTS NUMBER	ENGINE TYPE
	CYLINDER HEAD GASKET Silindir Kapak Contası 1 Notch / 1 Çentik	B – 417 6117 0417 6117 0417 0575	DEUTZ F 2L1011
	CYLINDER HEAD GASKET Silindir Kapak Contası 2 Notch / 2 Çentik	B – 417 6118 0417 6118 0417 0576	DEUTZ F 2L1011
	CYLINDER HEAD GASKET Silindir Kapak Contası 3 Notch / 3 Çentik	B – 417 6119 0417 6119 0417 0577	DEUTZ F 2L1011
	VALVE COVER GASKET Supap Kapak Contası	B – 417 3857 0417 3857 0417 0577	DEUTZ F 2L1011
	TOP GASKET SET Without Cylinder Head Gasket Üst Takım Conta Silindir Kapak Contası Hariç	B – 292 9852 0292 9852	DEUTZ F 2L1011
	FULL GASKET SET Without Cylinder Head Gasket Tam Takım Conta Silindir Kapak Contası Hariç	B – 292 8881 0292 8881	DEUTZ F 2L1011
	CYLINDER HEAD GASKET Silindir Kapak Contası 1 Notch / 1 Çentik	B – 417 8861 0417 8861 0427 1651	DEUTZ F 2L1011F Turbo F 2M1011F Turbo

PHOTOS	DESCRIPTIONS	PARTS NUMBER	ENGINE TYPE
	CYLINDER HEAD GASKET Silindir Kapak Contası 2 Notch / 2 Çentik	B – 417 8862 0417 8862 0427 1652	DEUTZ F 2L1011F Turbo F 2M1011F Turbo
	CYLINDER HEAD GASKET Silindir Kapak Contası 3 Notch / 3 Çentik	B – 417 8863 0417 8863 0427 1653	DEUTZ F 2L1011F Turbo F 2M1011F Turbo
	VALVE COVER GASKET Supap Kapak Contası	B – 417 9845 0417 9845	DEUTZ F 2L1011F Turbo F 2M1011F Turbo
	TOP GASKET SET Without Cylinder Head Gasket Üst Takım Conta Üst Takım Conta	B – 293 1742 0293 1742	DEUTZ F 2L1011F Turbo BF 2L1011F Turbo
	FULL GASKET SET Without Cylinder Head Gasket Tam Takım Conta Silindir Kapak Contası Hariç	B – 292 9856 0292 9856	DEUTZ F 2L1011F Turbo BF 2L1011F Turbo
	CYLINDER HEAD GASKET Silindir Kapak Contası 1 Notch / 1 Çentik	B – 417 6489 0417 6489	DEUTZ F 3L1011
	CYLINDER HEAD GASKET Silindir Kapak Contası 2 Notch / 2 Çentik	B – 417 6490 0417 6490	DEUTZ F 3L1011

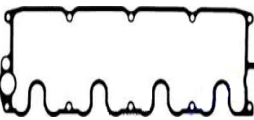

PHOTOS	DESCRIPTIONS	PARTS NUMBER	ENGINE TYPE
	CYLINDER HEAD GASKET Silindir Kapak Contası 3 Notch / 3 Çentik	B – 417 6491 0417 6491	DEUTZ F 3L1011
	VALVE COVER GASKET Supap Kapak Contası	B – 417 3858 0417 3858	DEUTZ F 3L1011
	TOP GASKET SET Without Cylinder Head Gasket Üst Takım Conta Üst Takım Conta	B – 292 8844 0292 8844	DEUTZ F 3L1011
	FULL GASKET SET Without Cylinder Head Gasket Tam Takım Conta Silindir Kapak Contası Hariç	B – 292 8729 0292 8729	DEUTZ F 3L1011
	CYLINDER HEAD GASKET Silindir Kapak Contası 1 Notch / 1 Çentik	B – 427 1264 0427 1264	DEUTZ F 3L1011F Turbo F 3M1011F Turbo
	CYLINDER HEAD GASKET Silindir Kapak Contası 2 Notch / 2 Çentik	B – 417 6493 0417 6493	DEUTZ F 3L1011F Turbo F 3M1011F Turbo
	CYLINDER HEAD GASKET Silindir Kapak Contası 3 Notch / 3 Çentik	B – 417 6492 0417 6492	DEUTZ F 3L1011F Turbo F 3M1011F Turbo

PHOTOS	DESCRIPTIONS	PARTS NUMBER	ENGINE TYPE
	VALVE COVER GASKET Supap Kapak Contası	B – 417 9846 0417 9846	DEUTZ F 3L1011F Turbo F 3M1011F Turbo
	TOP GASKET SET Without Cylinder Head Gasket Üst Takım Conta Üst Takım Conta	B – 292 9853 0292 9853 0293 1743	DEUTZ F 3L1011F Turbo BF 3L1011F Turbo
	FULL GASKET SET Without Cylinder Head Gasket Tam Takım Conta Silindir Kapak Contası Hariç	B – 293 1118 0293 1118	DEUTZ F 3L1011F Turbo BF 3L1011F Turbo
	CYLINDER HEAD GASKET Silindir Kapak Contası 1 Notch / 1 Çentik	B – 0417 0569 0417 0569	DEUTZ F 4L1011
	CYLINDER HEAD GASKET Silindir Kapak Contası 2 Notch / 2 Çentik	B – 0417 0570 0417 0570	DEUTZ F 4L1011
	CYLINDER HEAD GASKET Silindir Kapak Contası 3 Notch / 3 Çentik	B – 0417 0571 0417 0571	DEUTZ F 4L1011
	VALVE COVER GASKET Supap Kapak Contası	B – 417 3859 0417 3859	DEUTZ F 4L1011 F 4M1011

PHOTOS	DESCRIPTIONS	PARTS NUMBER	ENGINE TYPE
	TOP GASKET SET Without Cylinder Head Gasket Üst Takım Conta Üst Takım Conta	B – 292 8845 0292 8845 0292 8979	DEUTZ F 4L1011 F 4M1011
	FULL GASKET SET Without Cylinder Head Gasket Tam Takım Conta Silindir Kapak Contası Hariç	B – 292 8729 0292 8729	DEUTZ F 4L1011 F 4M1011
	CYLINDER HEAD GASKET Silindir Kapak Contası 1 Notch / 1 Çentik	B – 427 1157 0427 1157 0427 1631 0417 8867	DEUTZ F 4L1011F Turbo F 4M1011F Turbo
	CYLINDER HEAD GASKET Silindir Kapak Contası 2 Notch / 2 Çentik	B – 427 1158 0427 1158 0427 1632	DEUTZ F 4L1011F Turbo F 4M1011F Turbo
	CYLINDER HEAD GASKET Silindir Kapak Contası 3 Notch / 3 Çentik	B – 427 1159 0427 1159 0427 1633	DEUTZ F 4L1011F Turbo F 4M1011F Turbo
	VALVE COVER GASKET Supap Kapak Contası	B – 417 9847 0417 8175 0410 2939	DEUTZ F 4L1011F Turbo F 4M1011F Turbo
	TOP GASKET SET Without Cylinder Head Gasket Üst Takım Conta Üst Takım Conta	B – 292 9854 0292 9854	DEUTZ F 4L1011F Turbo F 4M1011F Turbo

PHOTOS	DESCRIPTIONS	PARTS NUMBER	ENGINE TYPE
	FULL GASKET SET Without Cylinder Head Gasket Tam Takım Conta Silindir Kapak Contası Hariç	B – 292 9856 0292 9856	DEUTZ F 4L1011F Turbo F 4M1011F Turbo
	MANIFOLD GASKET Manifold Contası	B – 410 2120 0410 2120 0417 9751	DEUTZ F/L1011 BF/L1011F Turbo
	MANIFOLD GASKET Manifold Contası	B – 417 4032 0417 4032 1215 9851	DEUTZ F/L1011 BF/L1011F Turbo
	MANIFOLD GASKET Manifold Contası	B – 417 3862 0417 3862 0427 2369	DEUTZ F/L1011 BF/L1011F Turbo
	VALVE STEM SEAL Ø8*15,2*9 mm Supap Keçesi (Lastiği)	B – 415 3728 0415 3728 0417 9944	DEUTZ F/L1011 BF/L1011F Turbo
	CRANKSHAFT FRONT OIL SEAL Ø105*125*13 mm Krank Mili Ön Keçesi	B – 417 5433 0417 5433 0210 8831	DEUTZ F/L1011 BF/L1011F Turbo
	CRANKSHAFT SEAL Ø55*75*10 mm Krank Mili Arka Keçesi	B – 417 5434 0417 5434 0210 8832	DEUTZ F/L1011 BF/L1011F Turbo

PHOTOS	DESCRIPTIONS	PARTS NUMBER	ENGINE TYPE
	CAMSHAFT SEAL Ø45*60*8 mm Eksantrik Mil Keçesi	B – 417 5435 0417 5435 0121 8946 0210 8833	DEUTZ F/L1011 BF/L1011F Turbo
	TURBOCHARGER <i>Turbo Model: TD04L-08T & TDO4-08/T</i> Turbo	B – 427 2458 0427 2458 0427 2325 49377-07700	DEUTZ (Bobcat 863) BF 4L1011F Turbo <i>Engine Series:</i> 000000541719 000000538083
	TURBOCHARGER Turbo	B – 417 8664 0417 8664	DEUTZ (Industrial engine) BF 4L1011F Turbo <i>Engine Series:</i> 000000034884 & 071300 000000037102 & 070971 000000053198
	TURBOCHARGER Turbo	B – 417 8665 0417 8665	DEUTZ (Industrial engine) BF 4L1011F Turbo <i>Engine Series:</i> 00008181568 & 035465 00000034887 & 070392 00000091167 & 054719
	TURBOCHARGER Turbo	B – 417 8666 0417 8666	DEUTZ (Industrial engine) BF 4L1011F Turbo <i>Engine Series:</i> 000000053007 000000022135 000000058012
	TURBOCHARGER Turbo	B – 427 0460 0427 0460 0427 2467	DEUTZ BF 4L1011F Turbo <i>Engine Series:</i> 0000146626 & 0235471 0008182746 & 0565335
	TURBOCHARGER Turbo	B – 427 0461 0427 0461 0427 2466	DEUTZ BF 4L1011F Turbo <i>Engine Series:</i> 000000147888 000000161907 000000161907 000005740405

PHOTOS	DESCRIPTIONS	PARTS NUMBER	ENGINE TYPE
	<p>TURBOCHARGER</p> <p>Turbo</p>	<p>B – 427 0462 0427 0462 0427 2467</p>	<p>DEUTZ BF 4L1011F Turbo</p> <p><i>Engine Series:</i> 000000144460 000000146476 000000215517</p>
	<p>TURBOCHARGER</p> <p>Turbo</p>	<p>B – 427 2460 0427 2460</p>	<p>DEUTZ BF3L/M1011F Turbo TCD 2011 L03</p> <p><i>Engine Series:</i> 0000105685861 0000578450 & 0723442 0000314864 & 0547314</p>
	<p>TURBOCHARGER</p> <p>Turbo</p>	<p>B – 427 2501 0427 2501 0427 1744 0427 1661</p>	<p>DEUTZ BF3L/M1011F Turbo BF 4L1011F Turbo</p> <p><i>Engine Series:</i> 000582898 & 0579130 00008181568 & 035465 00000034887 & 070392 00000091167 & 054719</p>

DEUTZ & DEUTZ VOLVO MOTOR GURUBUNA UYUMLU YANSANAYİ YEDEK PARÇANIN ADRESİ

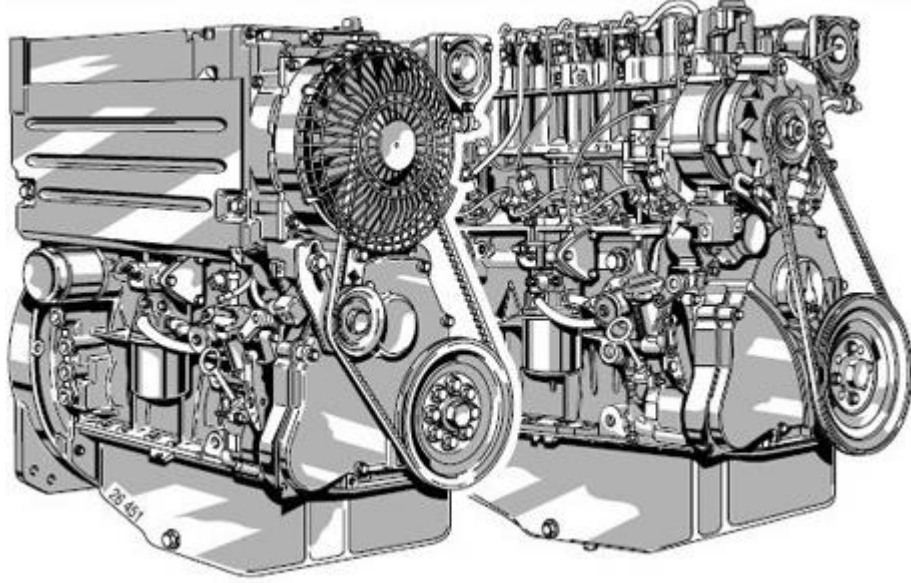

EMRE OTOMOTIV MOTORLU ARAÇLAR YEDEK PARÇA SAN. VE TİC. LTD. ŞTİ

İkitelli Organize Sanayi Bölgesi
Dolapdere Sanayi Sitesi 19.Ada No: 38
34490, Başakşehir / İstanbul – TÜRKİYE
Tel : +90 (212) 235 7 687
Tel : +90 (212) 235 7 688
Fax : +90 (212) 237 2 98